

Complete Unit:
 Gas Round Firepit - 600mm
 Gas Firepit Burner - 500mm

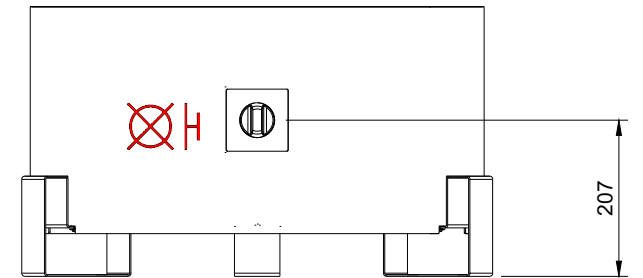
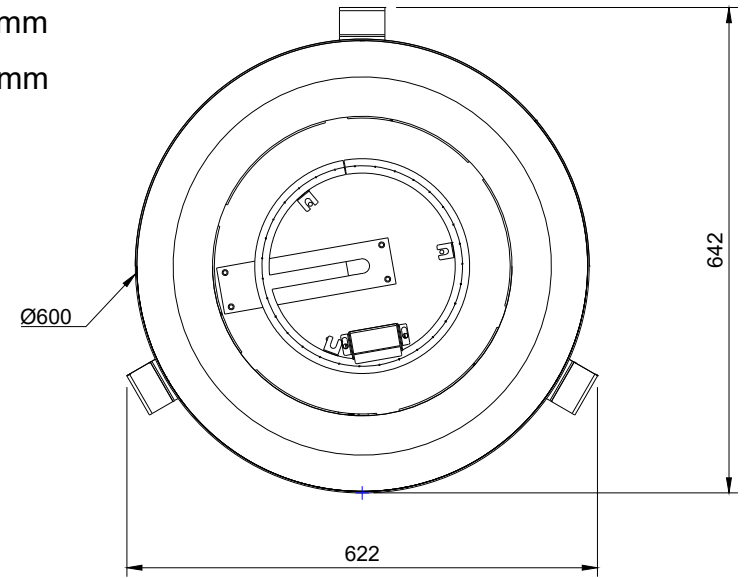
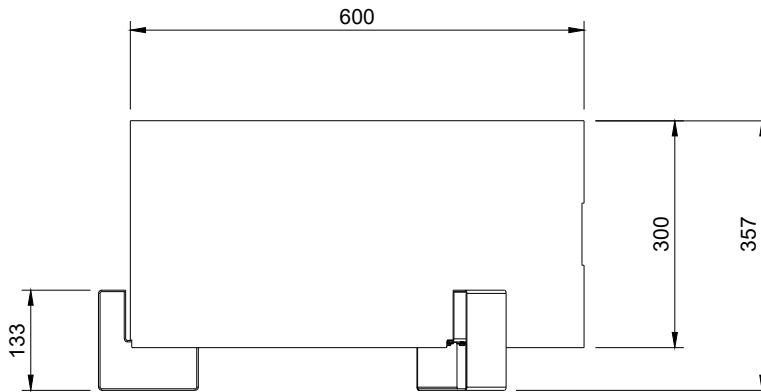
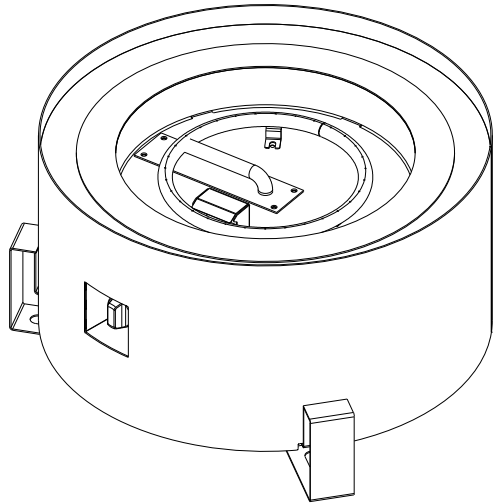

600 Gas Round Firepit

MOD-RNDFP-0-600-0-G-MS-0000-SF-CAA-Round Firepit ASM

This drawing is copyright and remains the property of Signi Fires. It may not be retained, copied, or used without written consent.

Estimated Unit Weight	Electrical supply by specialist unit for light fitting.	Gas supply by specialist.
16.0 kg	Projection 	Scale 1:10
	Sheet A4	Creation Date 2025/12/01