

Complete Unit:

- Counter Top Braai Body - 1200
- Ember Insert Braai Body - 1000
- 970 - Ember Wood Insert with
Ember Maker & Grid

Optional:

- Shelves

Signi Fires™

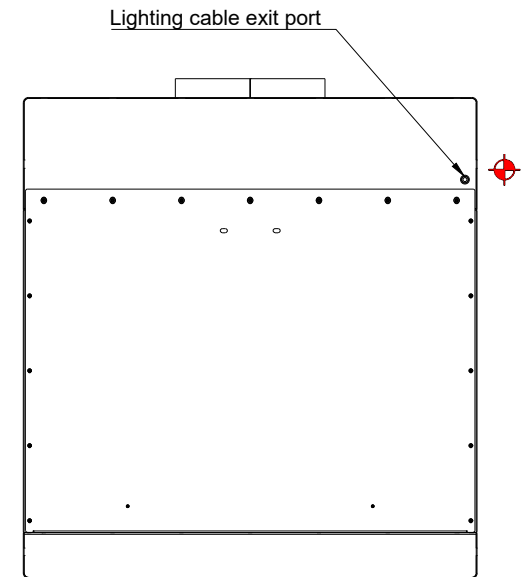
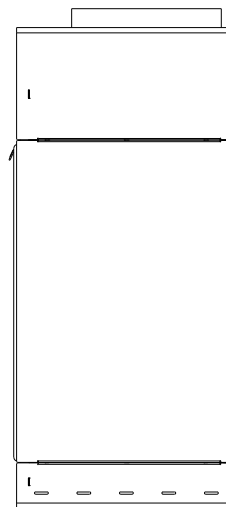
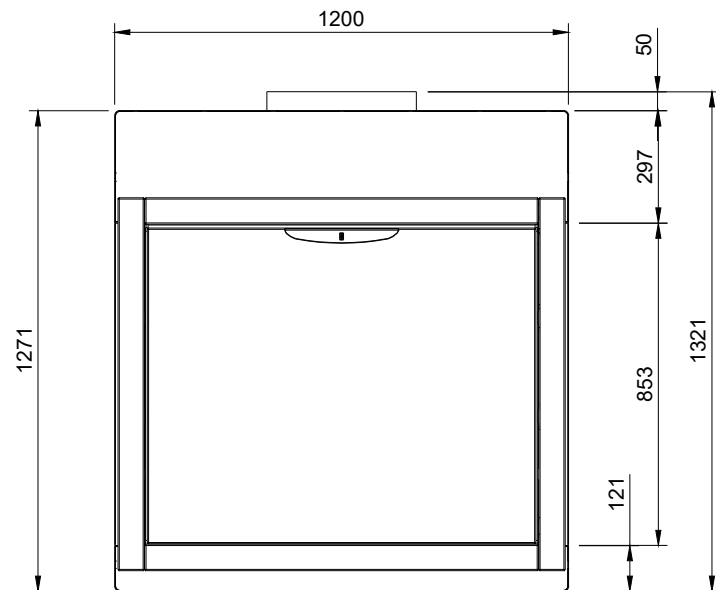
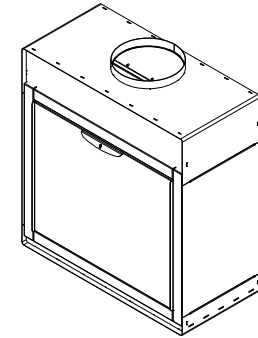

Free Standing Braai Body 1200 - Counter Top

BBQ-FSB-0-1200-0-N-MS-0000-Signi-CBA-ASM

This drawing is copyright and remains the property of Signi Fires. It may not be retained, copied, or used without written consent.

Est. Unit Weight	Projection	Scale	Sheet	Creation Date
197.0 kg		1:20	A4	2025/09/23

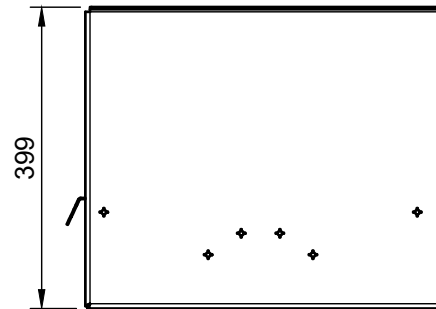
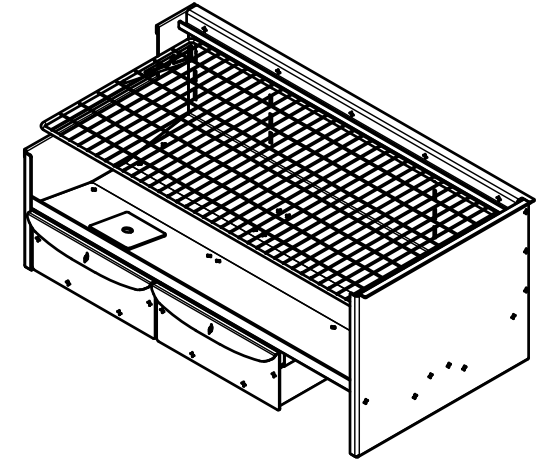
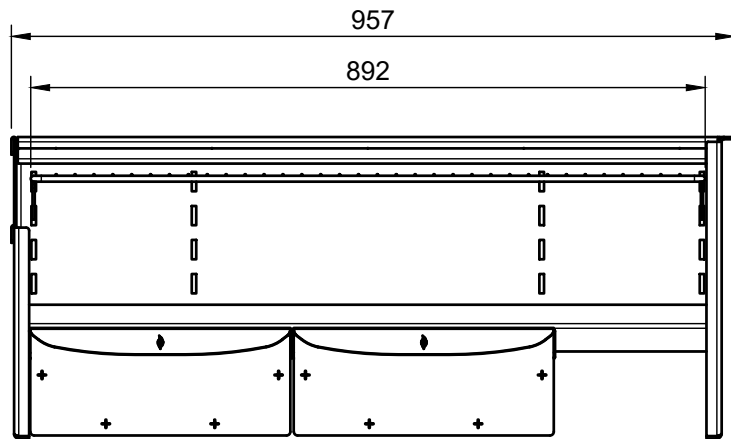
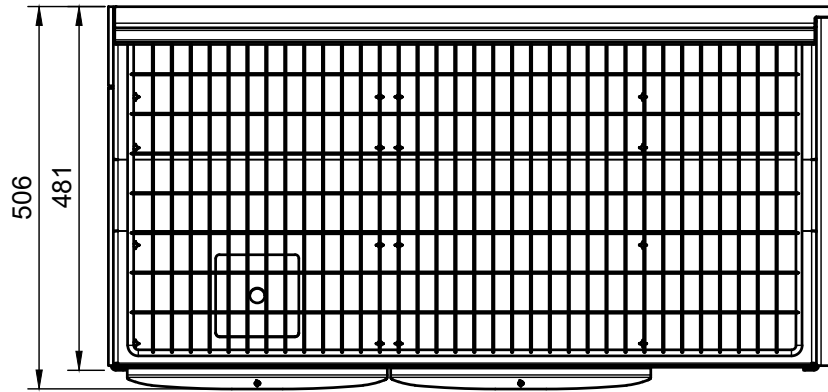



Installation Notes:

Blank area for installation notes.

Product Description

Ember Wood Insert 970 - Full Grid

 Electrical supply by specialist unit for light fitting.

 Gas supply by specialist for gas griller insert.

Product Title

BBQ-Ember Wood Insert-970MS-030203-0000-Signi-CA-ASM

Signi Fires™

General Notes:
Do Not Scale From Drawing
This drawing is copyright and remains the property of Signi Fires. It may not be retained, copied, or used without written consent.

Designer
Dewald Basson

Creation Date
2024/01/28

Unless Otherwise Specified
Dimensions are in millimeters
Tolerances
X.X = ± 0.5
X.XX = ± 0.05
X.XXX = ± 0.005

This Document Contains Confidential And Proprietary Information That Cannot Be Reproduced Or Divulged, In Whole Or In Part, Without Written Authorization From Signi Fires.

Projection	Scale	Sheet	Sheet Count
	1:10	A4	1/1

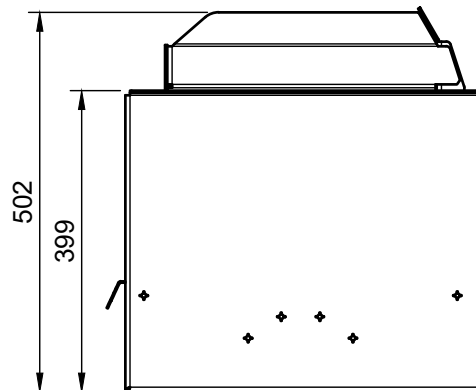
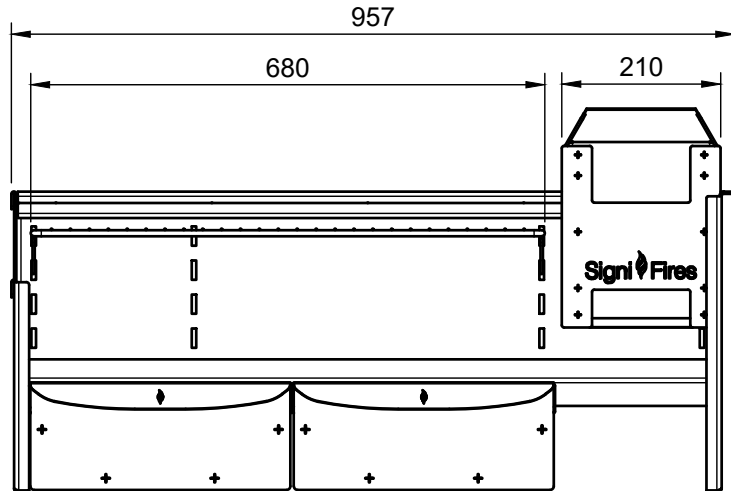
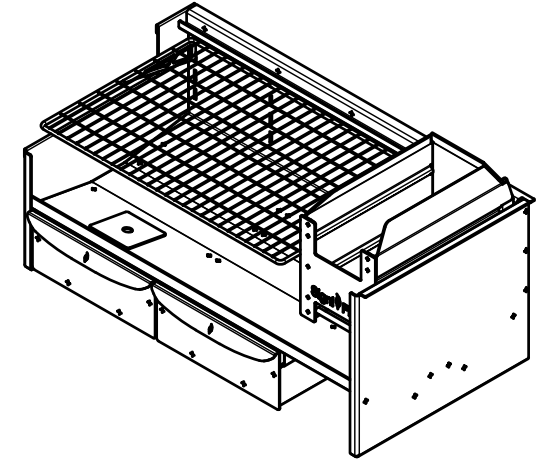
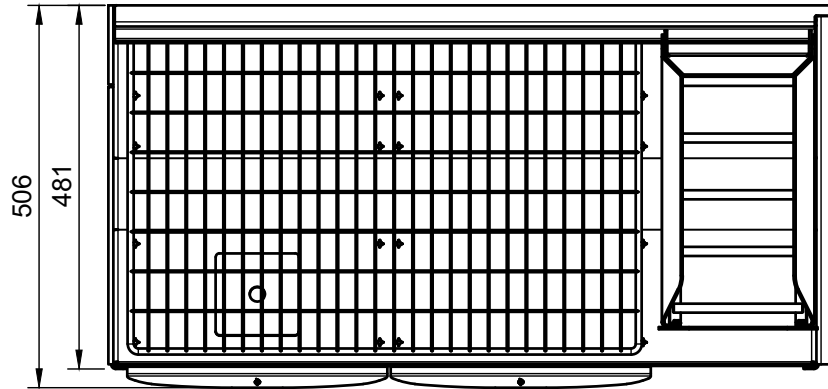



Installation Notes:

Blank area for installation notes.

Product Description

Ember Wood Insert 970

 Electrical supply by specialist unit for light fitting.

 Gas supply by specialist for gas griller insert.

Product Title

BBQ-Ember Wood Insert-970MS-030203-0000-Signi-CA-ASM



General Notes:
Do Not Scale From Drawing
This drawing is copyright and remains the property of Signi Fires. It may not be retained, copied, or used without written consent.

Designer
Dewald Basson
Creation Date
2024/01/28

Unless Otherwise Specified
Dimensions are in millimeters
Tolerances
X.X = ± 0.5
X.XX = ± 0.05
X.XXX = ± 0.005

This Document Contains Confidential And Proprietary Information That Cannot Be Reproduced Or Divulged, In Whole Or In Part, Without Written Authorization From Signi Fires.

Projection	Scale	Sheet	Sheet Count
	1:10	A4	1/1