

FORGE FIRES

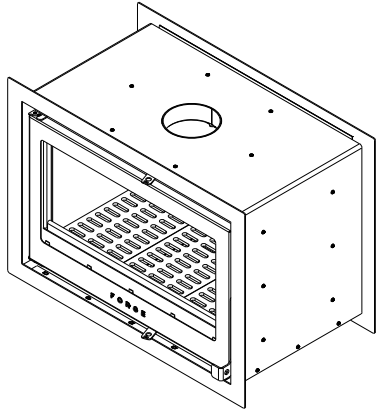
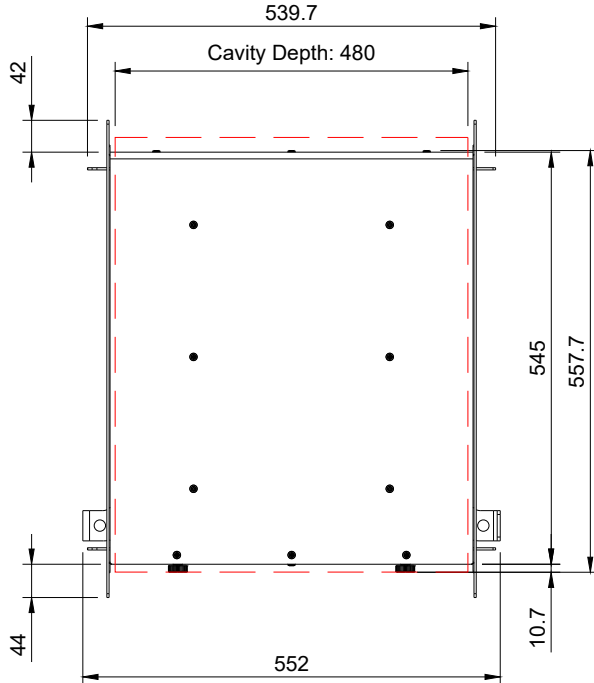
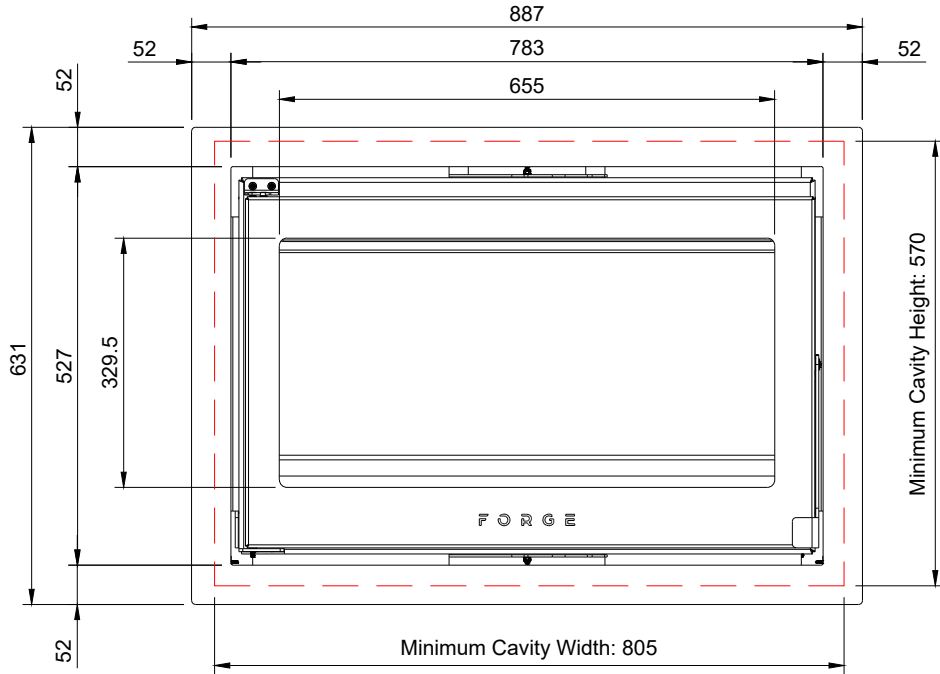
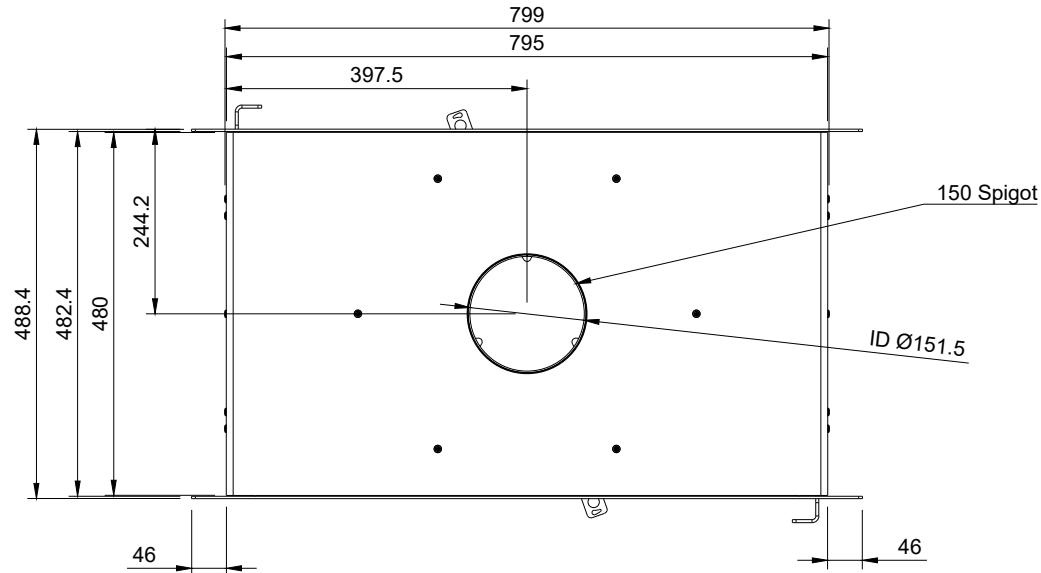

Forge F80 Double Sided Insert

FDSR-MS-INS-800-0-W-CA
 This drawing is copyright and remains the property of Signi Fires. It may not be retained, copied, or used without written consent.

Projection	Scale	Sheet	Creation Date
	1:10	A4	2026/05/05